

systemtronic

datasheet DROP OUT



General description:

Original umbrella stand made of galvanized steel sheet with two separate buckets, one for long umbrellas and another bucket for folding ones, the colours of both can combine.

Designer: STC Studio.



Descripción Técnica:

DROT

·Materials:

Main structure+small umbrella stand: galvanized steel.
Water collects: polystyrene.

·Dimensions: 420x180x507mm 16.54x7.09x19.96"

DROTOL

·Materials:

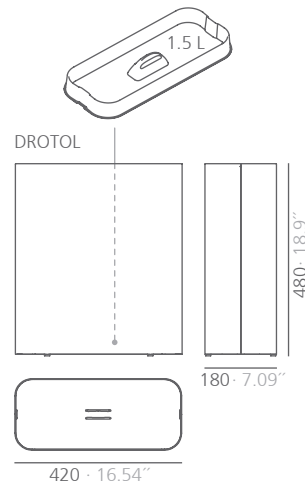
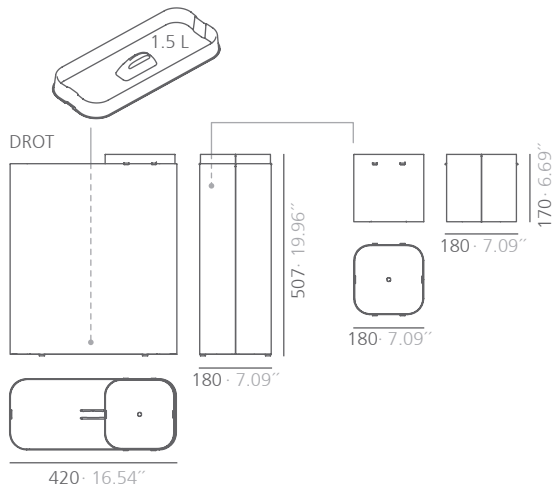

Main structure without small umbrella stand: galvanized steel.
Water collects: polystyrene.

·Dimensions: 420x180x480mm 16.54x7.09x18.9"

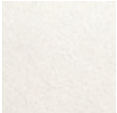
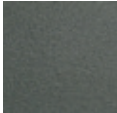
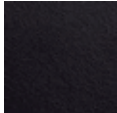

SI units: mm and inches.

Finishes:

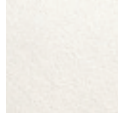
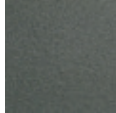
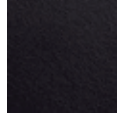
Main structure			Small umbrella stand					
								
textured white	textured forged grey	textured black RAL 9011	mustard gloss RAL 1012	grey beige gloss RAL 1019	textured white	textured forge grey	textured black RAL 9011	
*Polyester paint								

Consult for special dimensions or any other modification.

Maintenance:

-Polyester Paint:

For dry dirt (dust), use a damp cloth. For greasy/oily stains (fingerprints), wipe with a sponge with water and dishwashing liquid. Rinse with a damp cloth. Avoid using products containing solvents and/or pure ethyl alcohol.

-Aluminium-metal-glass-melamine-plastic:

We recommend using normal cleaning products for delicate surfaces. Alcohol, solvents and abrasive agents must be avoided.