

QUARTZ FOLDING CHAIR

By Ramon Esteve



The Quartz collection is characterized by its orthogonal geometry and triangular shaped profiles. Due to the line of one of its vertexes this piece appears extremely light. Inspired by the Quartz Stone and it's properties such as it's hardness and strength, in addition to the distinctive finish of it's shapes. Our chairs have clean cut lines and geometric lightness that blend totally in any environment. Primarily, the Quartz collection stands out for its quest for neutrality and its timeless design.

View online: <https://www.vondom.com/products/54197>

Features

Description

Made of gas air moulding injected polyamide with fiber glass. Stackable. Available in 3 colors. Item suitable for indoor and outdoor use.

Weight

4.7 Kg

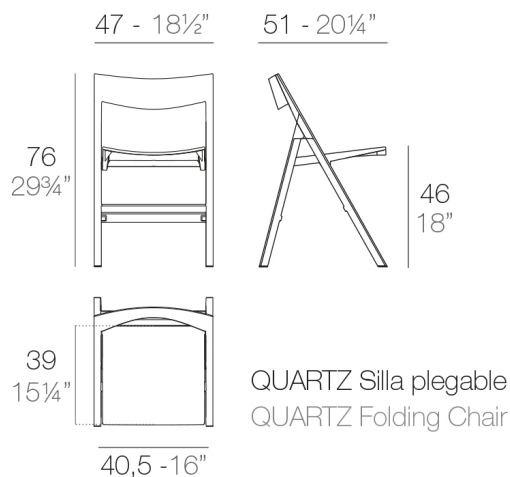

Finishes

BASIC PP

Ref. 54197

Available in various colors

COLOR	BASIC PP
ECRU 3111	
BLACK 3126	
WHITE 3102	
WHITE	
BLACK	
ECRU	

